

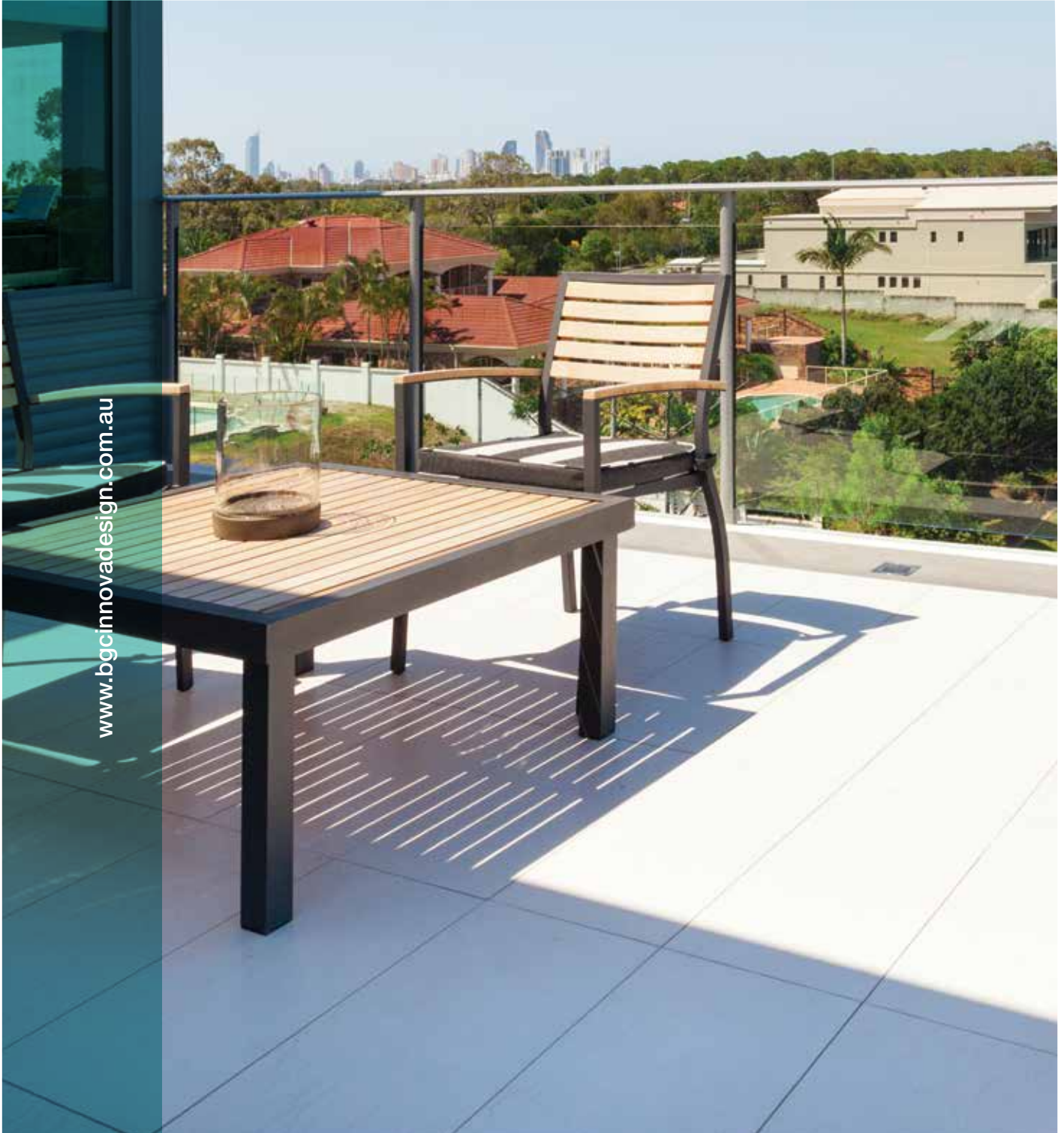

DURAFLOOR™
FLOORING SYSTEM



www.bgcinnovadesign.com.au

BGC's stunning range of facade, lining and flooring products, InnovaTM will move you to reassess your concept of excellence in facades and flooring systems. Durable and dynamic, fresh and contemporary, InnovaTM is already turning industry heads. Now let the InnovaTM range of cladding and flooring products breathe new life into your creativity and project specification.

Contents

- 5 // Applications
- 5 // Advantages
- 5 // Product Information
- 5 // Fire Resistance
- 5 // Sheet Sizes and Weight
- 5 // Sheet Properties
- 5 // Sheet Tolerances
- 5 // Energy Efficiency Considerations
- 5 // Quality Systems
- 6 // Handling and Storage
- 6 // Cutting and Drilling
- 6 // Health and Safety
- 6 // Fasteners
- 6 // Holes
- 7-14 // Interior Information
- 15-22 // Exterior Information
- 22 // Sheet Preparation
- 22 // Membranes
- 22 // Maintenance
- 22 // Warranty
- 22 // Terms and Conditions

DURAFLOOR™ FLOORING SYSTEM

DURAFLOOR™ is the ultimate flooring product that can be used in both interior and exterior applications. DURAFLOOR™ is ideally suited to interior wet areas as well as exterior projects.

- / Easily installed using traditional gun nailing methods.
- / Reduces installation costs compared to standard compressed sheet.
- / Uses same tongue and groove technology as traditional sheet flooring such as structaflor®.
- / **Can be used in Interior wet areas.**
 - / Bathrooms
 - / Laundries
- / **Can be used in Exterior applications**
 - / Balconies
 - / Verandas
 - / Sundecks
 - / Or as a total floor solution where a premium product is required.
 - / Has greater impact resistance and feels more solid than timber based sheet flooring products.

Case Study 01.

'The area we used Durafloor™ is subject to very heavy traffic as it is just in front of the start gates. We needed a durable but flexible product that had a bit of give to absorb the impact from cyclists as well as being a stable product that is suitable to the wet and humid climate in Darwin'.

Another benefit of Durafloor™ is that it is easy and fast to install. This project was complex because the shape of the ramp is

irregular so selection of a cement sheet that was easy to cut on site and quick to install was very important for us as the builder.

Once installed, we finished the Durafloor fibre cement with a special epoxy paint which provided a non-slip surface'.

Mark Smeaton
Construction Director / Ahrens

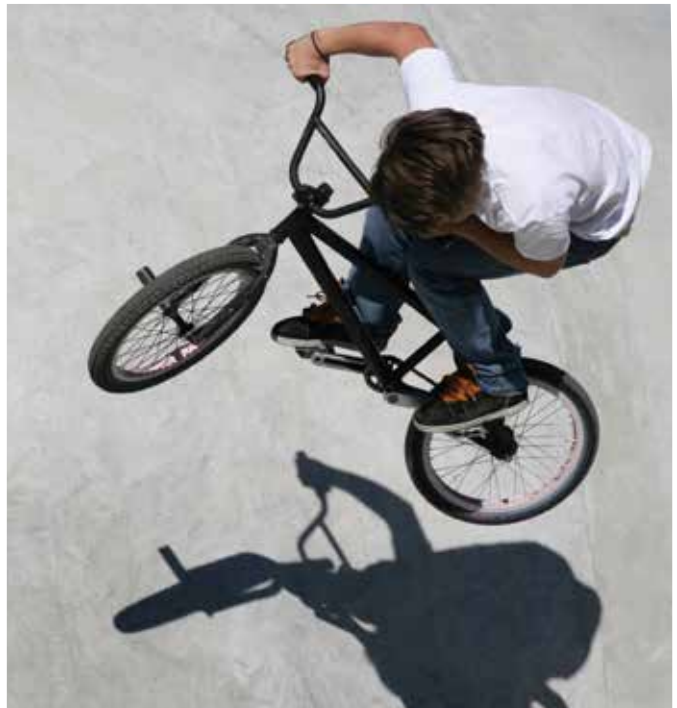
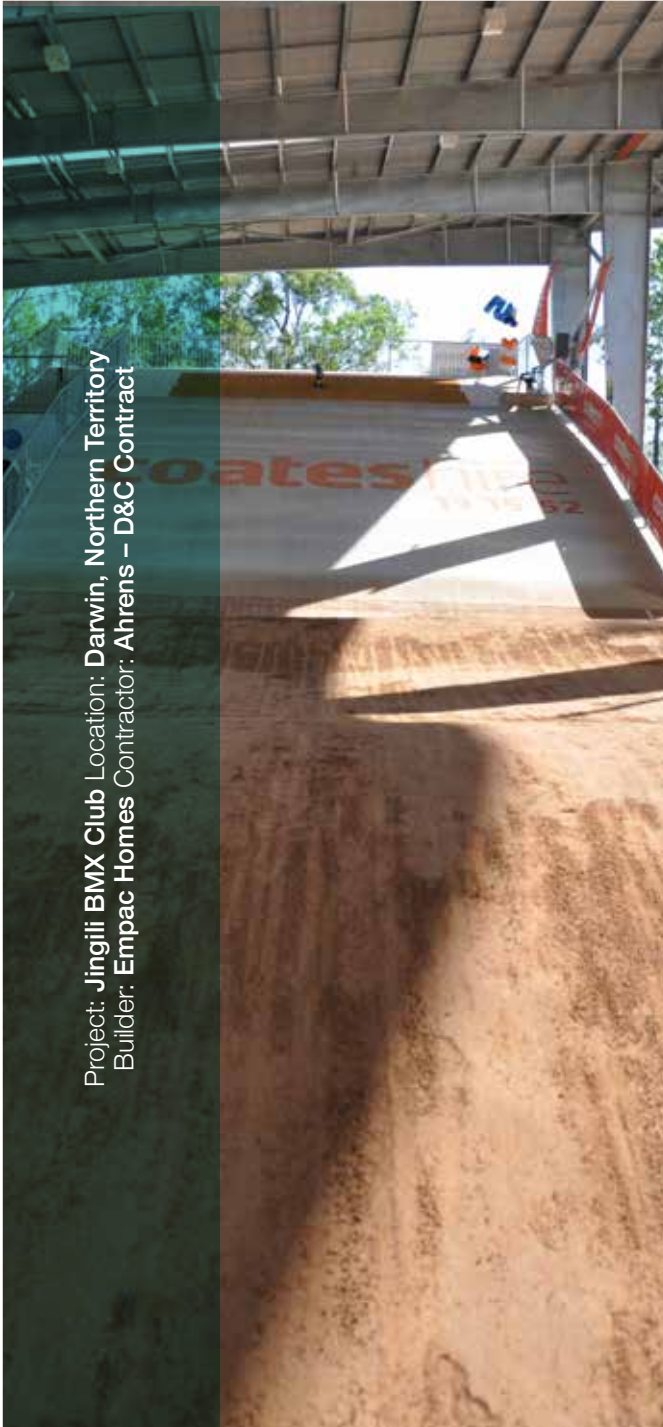

Applications

Durafloor™ is the perfect product to use for interior wet area projects such as bathrooms and laundries but is also ideal for use as the substrate for a variety of exterior decking applications such as above-ground pool surrounds, verandahs and balconies.

Advantages

- / A single product for interior and exterior projects
- / Tongue and groove system that fits well with particleboard flooring products
- / Easily installed using traditional gun nailing methods reducing installation costs
- / Has greater impact resistance and feels more solid underfoot than timber-based sheet flooring products

Product Information

Durafloor™ is manufactured from cement, finely ground silica, cellulose fibres and water. After forming it is then cured in a high-pressure steam autoclave to create a durable, dimensionally stable product.

Durafloor™ is immune to permanent damage from water. It is impact resistant, immune to termite attack, non-combustible and easy to work.

Durafloor™ is manufactured to conform to the requirements of AS2908 Cellulose Cement Products, and is classified as Type A Category 3 for external use.

Fire Resistance

BGC Fibre Cement products have been tested in accordance with Australian Standard AS1530.3.

These tests deemed the following Early Fire Hazard Indices:

- / Ignition Index 0
- / Spread of Flame Index 0
- / Heat Evolved Index 0
- / Smoke Developed Index 0-1

Durafloor™ is deemed to be non-combustible in accordance with BCA section C1.12.

Energy Efficiency Considerations

Energy efficiency requirements have been introduced into the BCA for both commercial and residential buildings. Thermal heat transfer into and out of the building envelope can affect the running cost of the building and careful consideration of thermal heat transfer needs to be addressed by the architects, engineers and building designers. Thermal bridging through steel framing will diminish the total R-Value; (thermal conductance of the wall). Thermal breaks are required for steel-framed buildings and should be installed between the lightweight steel CFS stud and the Durafloor™.

Thermal breaks should have a minimum R-Value of 0.2 or less.

Quality Systems

Durafloor™ is manufactured under the rigorous Quality Management System of the International Standard ISO 9001.

Sheet Sizes and Weight

NOMINAL THICKNESS mm	WEIGHT kg/m ²	WIDTH mm	LENGTH mm	
			2250	2700
19	26.2	600	✓	✓

Weight is based on Equilibrium Moisture Content.

Sheet Properties

DENSITY	1300kg/m ³
FREEZE-THAW TEST	Passed
WARM WATER TEST	Passed
SOAK AND DRY TEST	Passed
WATER PERMEABILITY	Passed
BENDING STRENGTH	Greater than 7MPa at Saturated condition

Sheet Tolerances

Durafloor™ complies with the requirements of AS2908.2

DURAFLOOR™

FLOORING SYSTEM

Handling and Storage

Durafloor™ must be stacked flat, up off the ground and supported on equally spaced level bearers at 450mm centres.

Durafloor™ must be kept dry, preferably by being stored inside a building. When stored outdoors it must be protected from the weather.

Care should be taken to avoid damage to the ends, edges and surfaces.

Durafloor™ must be dry prior to fixing, jointing or finishing.

Cutting and Drilling

Durafloor™ can be cut to size on site. Either Tungsten Carbide or Diamond tipped tools are generally required.

For straight cuts BGC recommends the use of a BGC Durablade fitted to a 185mm circular saw, with a full dust extraction system.



Health and Safety

Durafloor™ sheeting is manufactured from cellulose fibre, finely ground sand, cement and additives. As manufactured the product will not release airborne dust, but during drilling, cutting and sanding operations cellulose fibres, silica and calcium silicate dust may be released.

Breathing in fine silica dust is hazardous, prolonged exposure (usually over several years) may cause bronchitis, silicosis or cancer.

Avoid Inhaling Dust

When cutting sheets, work in a well-ventilated area and use the methods recommended in this literature to minimise dust generation.

If using power tools for cutting, drilling or sanding they must be fitted with appropriate dust collection devices or alternatively use an approved (P1 or P2) dust mask and wear safety glasses.

These precautions are not necessary when stacking, unloading or handling fibre cement products.

For further information or a Material Safety Data Sheet contact the nearest BGC Sales Office.

Holes

For small holes a well-sharpened Tungsten Carbide masonry drill is recommended. Use a slow drill speed.

Do not use the drills hammer function.

For larger circular holes such as waste holes a Tungsten Carbide or diamond tipped hole saw is recommended.

Alternatively drill a series of small holes around the perimeter of the cut-out, and then gently tap out the waste piece while supporting the underside of the opening to avoid damage. Clean up any rough edges with a rasp.

Fasteners

Durafloor™ to Timber Frame

Powers Muro M1063 - 10g x 50



Paslode HDG Coil Nail 45 x 2.5



All fasteners to be corrosion resistant-Class 3 minimum.

Fasteners

Durafloor™ to Steel Frame

Buildex Wingtek Screw 10g x 16 x 40



Powers Muro M1024 CSK Screw - 8g x 42



Or similar

Wet Area Tiled Floors

Durafloor™ is ideally suited as a substrate for ceramic tiled floors in the wet areas such as bathrooms and laundries.

General

All waterproofing of internal wet areas must be carried out strictly in accordance with Australian Standards AS 3740-2010.

This manual does not contain all information relevant for waterproofing and is to be used as a guide only. It is the responsibility of the specifier to carry out all the necessary design and detailing to ensure the waterproofing and finish satisfy all relevant codes, regulations and system waterproofing manufacturer recommendations.

Framing

Durafloor™ sheeting can be fixed to either timber or lightweight steel framing.

Timber framing must comply with AS 1684 “Residential Timber Frame Construction”. Unseasoned timber must not be used.

Metal framing must comply with AS3623 “Domestic Metal Framing”.

BGC recommends sheets to be laid with the long edge across the joists. (Figure 2).

Joist spacing must not exceed 450mm maximum centres.

In all cases a floor joist must support the sheet end.

For all applications the joist face width must be no less than 45mm min.

DURAFLOOR™ NOMINAL THICKNESS (mm)	MAXIMUM JOIST CENTRES (mm)
19	450

Loading

Durafloor™ satisfies the loading requirements of AS/NZS1170.1 Table 3.1 Category A Domestic and Residential Activities Concentrated Loads 1.8kn @ UDL of 4KPA.

For higher load applications, BGC Compressed Flooring is recommended. Please contact your local BGC Fibre Cement office for further details, or refer to BGC Fibre Cement Compressed Flooring brochure.

Floor Drainage

In wet areas lay mortar bed (screed) at a minimum depth of 25mm over the Durafloor™ to produce a minimum 1:60 fall to the waste drain.

Figure 1 depicts a typical floor waste installation showing the waterproof membrane carried down into the fitting. The inner pipe is slotted to allow drainage of the mortar bed (screed).

Floor Waste Sketch

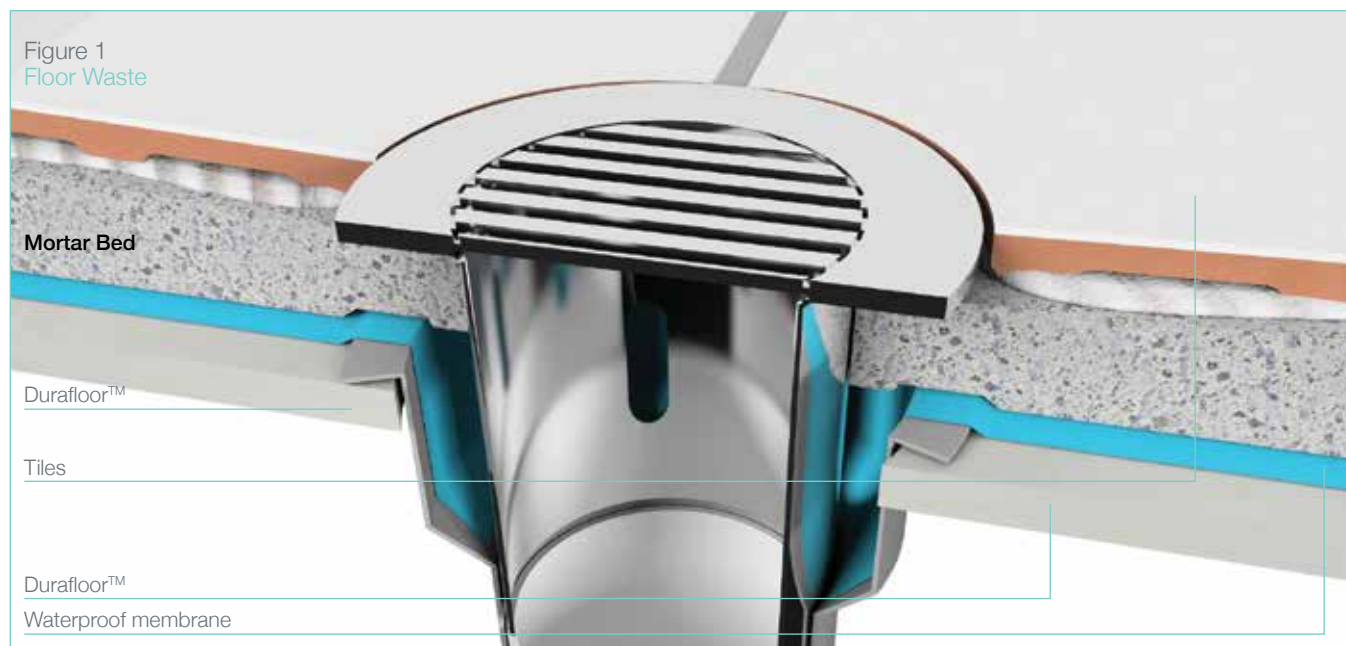

Tiled Shower Base Recess

Figure 2
Wet Area

ENSURE COMPLIANCE WITH THE BCA AND AS3740-2010

Notation order follows installation sequence.

- Durafloor™
- Duraliner™ Plus
- Mortar Bed*
- Primer*
- Waterproof Membrane*
- Tile Adhesive*
- Tiles*
- Perimeter Flashing*
- Waterproof Membrane*
- Primer*

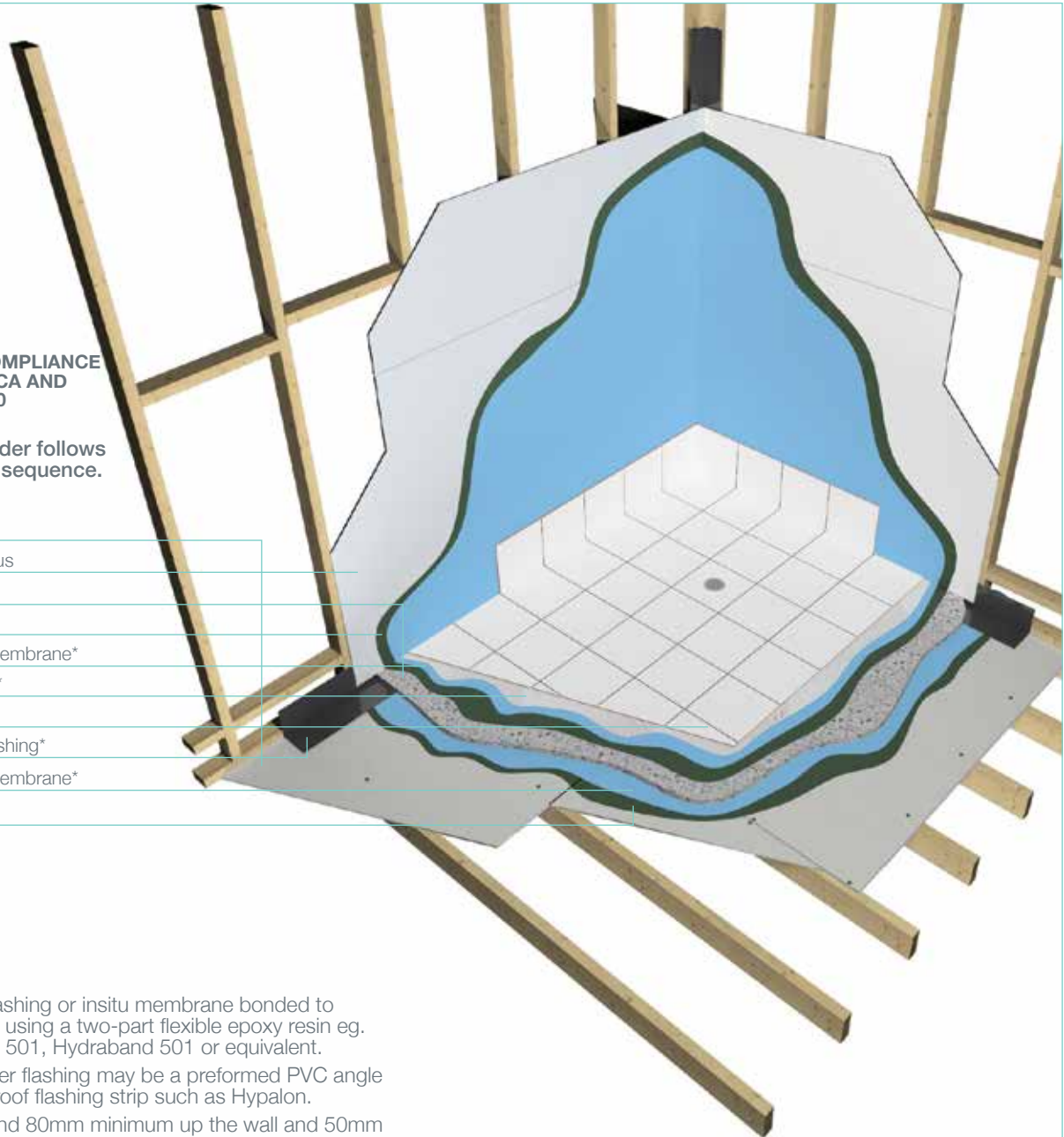

NOTE 2.1

Perimeter flashing or insitu membrane bonded to Durafloor™, using a two-part flexible epoxy resin eg. HydrExpoxy 501, Hydraband 501 or equivalent.

The perimeter flashing may be a preformed PVC angle or a waterproof flashing strip such as Hypalon.

It must extend 80mm minimum up the wall and 50mm across the floor. The corner detail must be waterproof.

The flashing or membrane must not be bonded to the wall studs.

NOTE 2.2

An additional wall nogging must be installed so that the bottom of the Duraliner™ Plus is fastened above the perimeter flashing.

NOTE 2.3

The Durafloor™ must be laid across the floor joists as shown.

NOTE 2.4

Lay waterproof membrane over Durafloor™ at a minimum of 150mm upstand of the perimeter flashing.

The membrane must be dressed into the floor waste. (See figure 1).

NOTE 2.5

Lay a mortar bed (screed) over the Durafloor™ to produce a 1:60 fall to the waste drain. See Figure 1.

Ensure all flashings and waterproofing comply with the BCA and AS3740-2010.

Optional regulation - Refer to local Building Authority.

Shower walls are to be water resistant to 1800mm from finished floor level.

Preformed Shower Base Recess

Particular attention is required to the sealing of shower alcoves or recesses.

As with all wet area applications strict adherence to the Building Code of Australia, AS 3740-2010 and local building regulations is essential.

Figures 3 & 4 depict a preformed shower base. Figure 5 depicts a waterproof membrane, which may be either preformed or insitu.

Figure 3
Shower Recess

**ENSURE COMPLIANCE WITH
THE BCA AND AS3740-2010**

Corner Flashing*

Primer*

Durafloor™

Duraliner™ Plus

Waste

Waterproof Membrane*

Perimeter Flashing*

Primer*

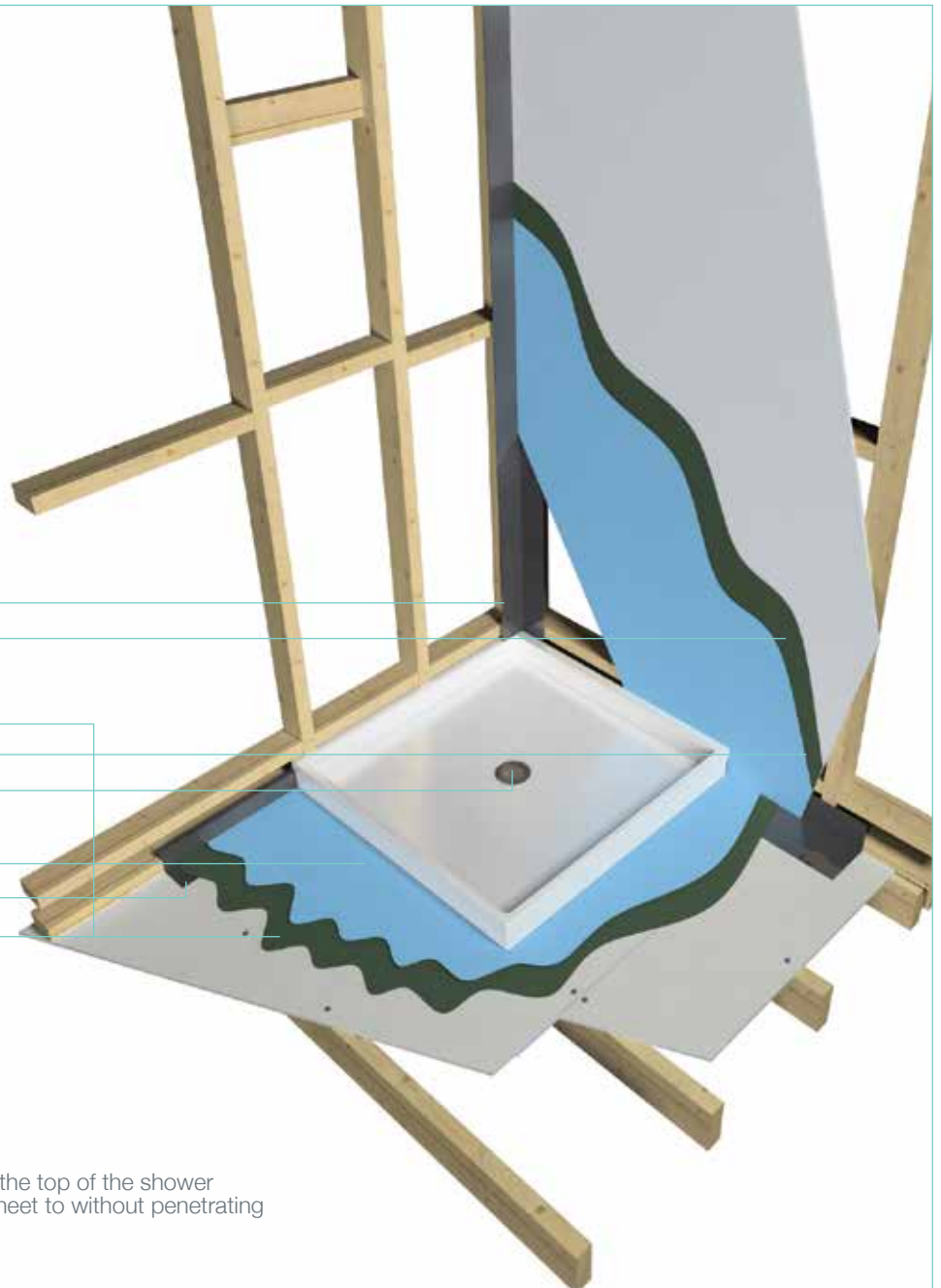

NOTE 3.1

A nogging is required 25mm above the top of the shower tray to fasten the Duraliner™ Plus sheet to without penetrating the perimeter flashing.

NOTE 3.2

Durafloor™ sheets are to be laid across the floor joists as shown.

Ensure all flashings and waterproofings comply with the BCA and AS3740 and local building authority.

Shower walls are to be water resistant to 1800mm from finished floor level.

Shower Recesses

Figure 4
Preformed Shower Base Detail

**ENSURE COMPLIANCE WITH
THE BCA AND AS3740-2010**

- Durafloor™
- Duraliner™ Plus
- Flashing*
- Perimeter Flashing, PEF Rod and Bond Breaker tape
- Primer*
- Waterproof Membrane*
- Shower base*
- Tiles*

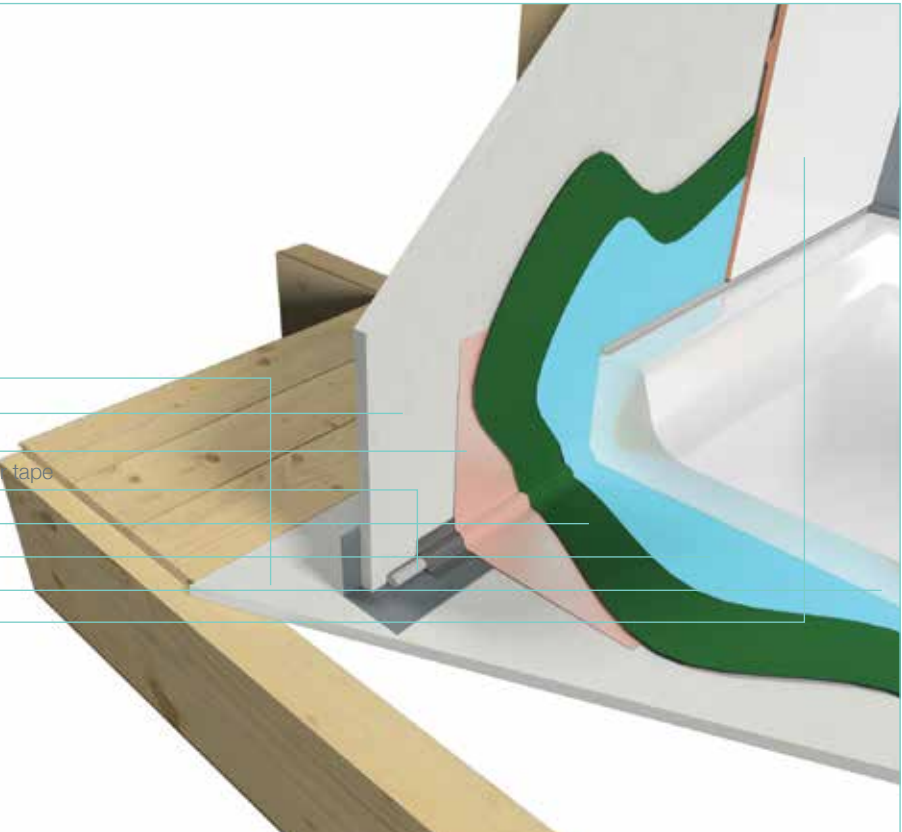
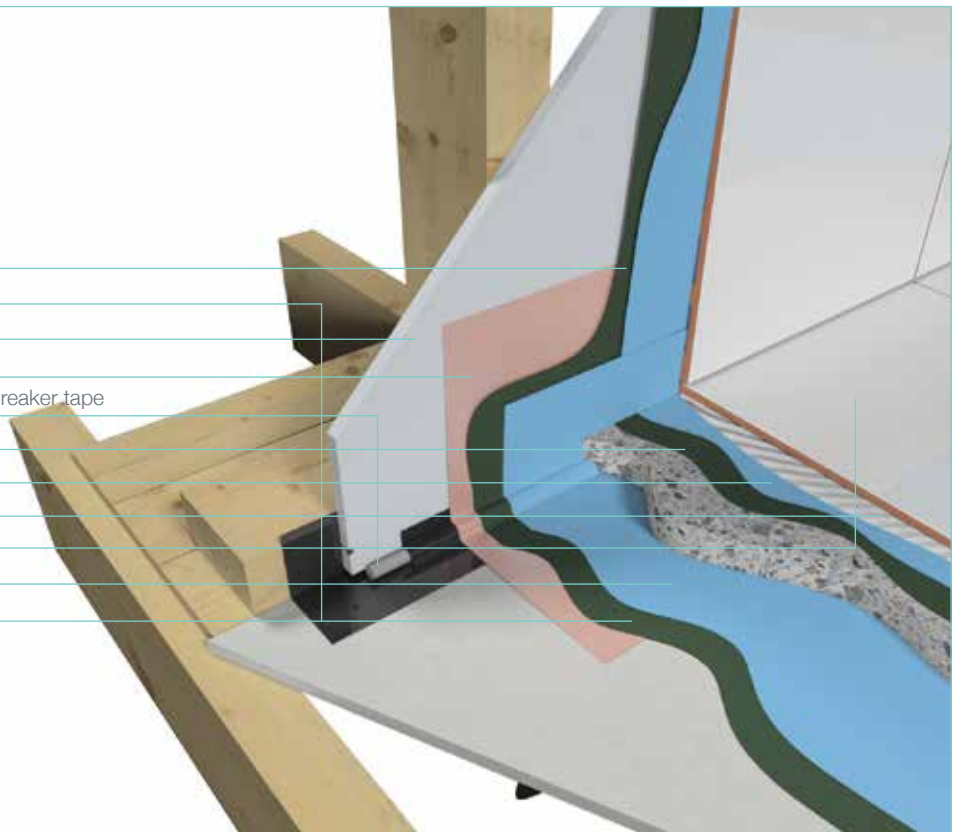

Figure 5
Using Waterproof Membrane

**ENSURE COMPLIANCE WITH
THE BCA AND AS3740**

- Primer*
- Durafloor™
- Duraliner™ Plus
- Flashing*
- Perimeter Flashing, PEF Rod and Bond Breaker tape
- Primer*
- Waterproof Membrane*
- Tile Adhesive*
- Tiles*
- Waterproof Membrane*
- Primer*



Interior Tiled Floors

In areas where floor waste drains are not required, for example kitchens, ceramic floor tiles may be fixed directly to the Durafloor™ using a proprietary tile adhesive conforming to

the Australia Standards AS2358 – Adhesives – for fixing ceramic tiles and AS3958.1 – ceramic tiles – Part 1 – Guide to the installation of ceramic tiles.

Sheet Layout

Suitable for wet areas with waterproof membrane fitted and tiled, and non-wet areas fitted with vinyl or carpet.

FIGURE 6
STAGGERED SHEET LAYOUT

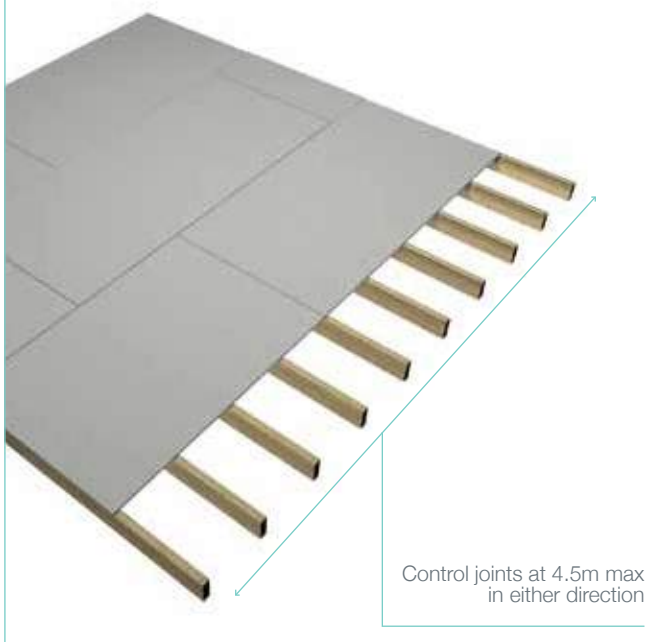

Suitable for non-wet areas tiled.

FIGURE 7
SQUARED SHEET LAYOUT



Installation Details - Interior Tiled Floors

Figure 8
Joist Spacing

Lay the sheets with long edges across the joists, with the ends of the sheet supported on the centre line of the joist as shown in Figure 9.

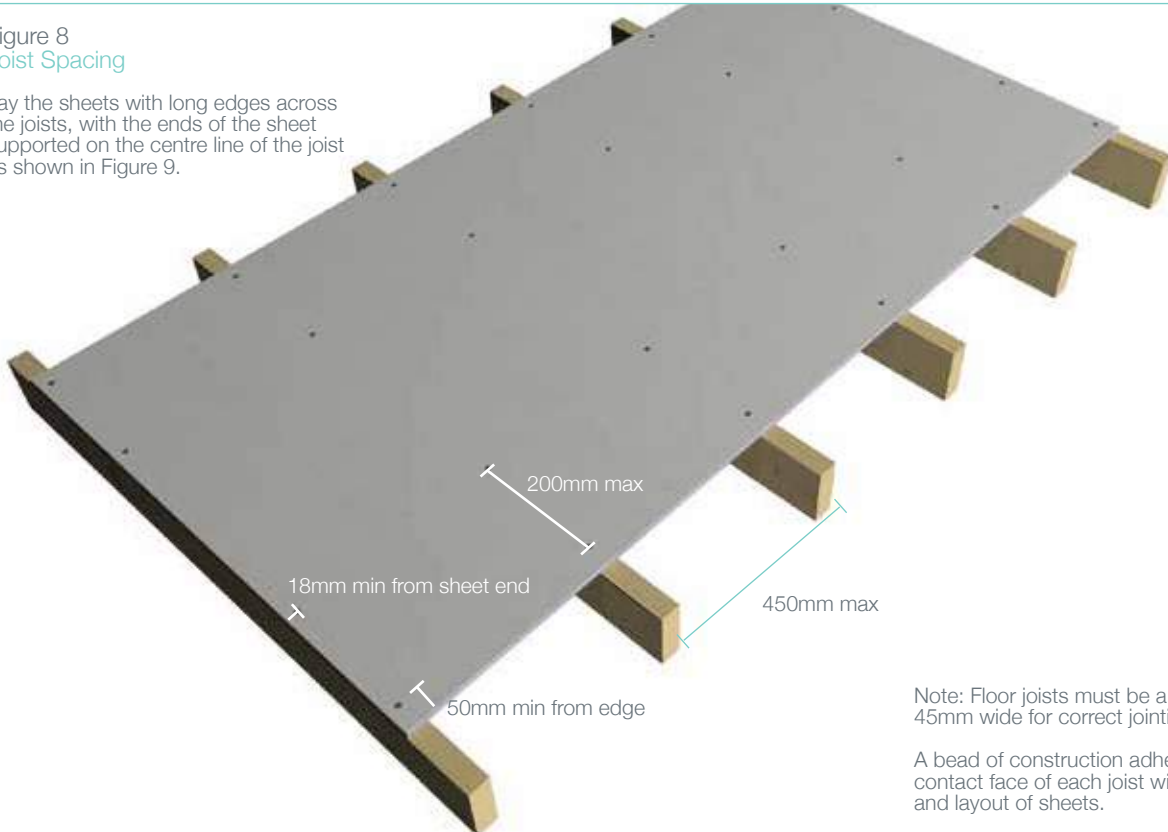

Note: Floor joists must be a minimum of 45mm wide for correct jointing.

A bead of construction adhesive on the contact face of each joist will assist fixing and layout of sheets.

Figure 9
Butt Join

Fasteners*

Durafloor™

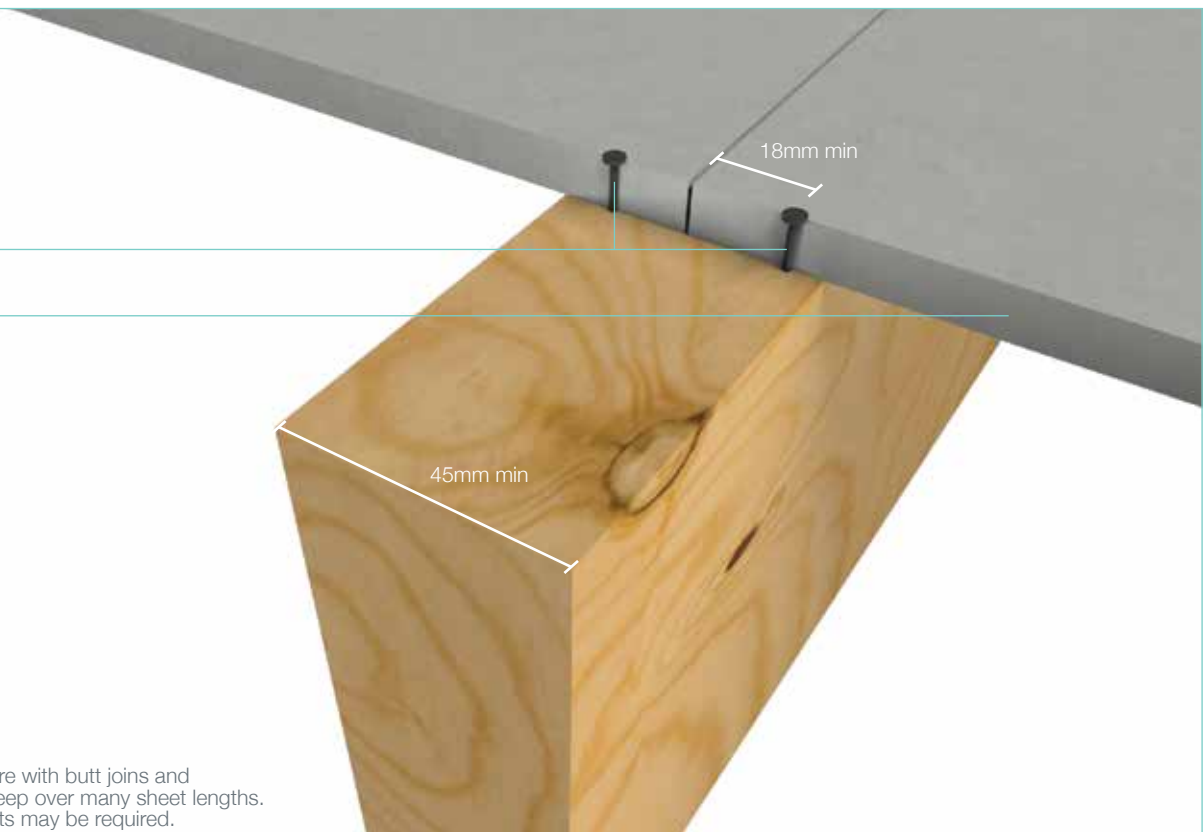

Note: Take care with butt joints and associated creep over many sheet lengths. Additional joists may be required.

Installation Details - Interior Tiled Floors

Figure 10
Wet Area Butt Join

Durafloor™
Fasteners*
Backing Rod*
Polyurethane Sealant*

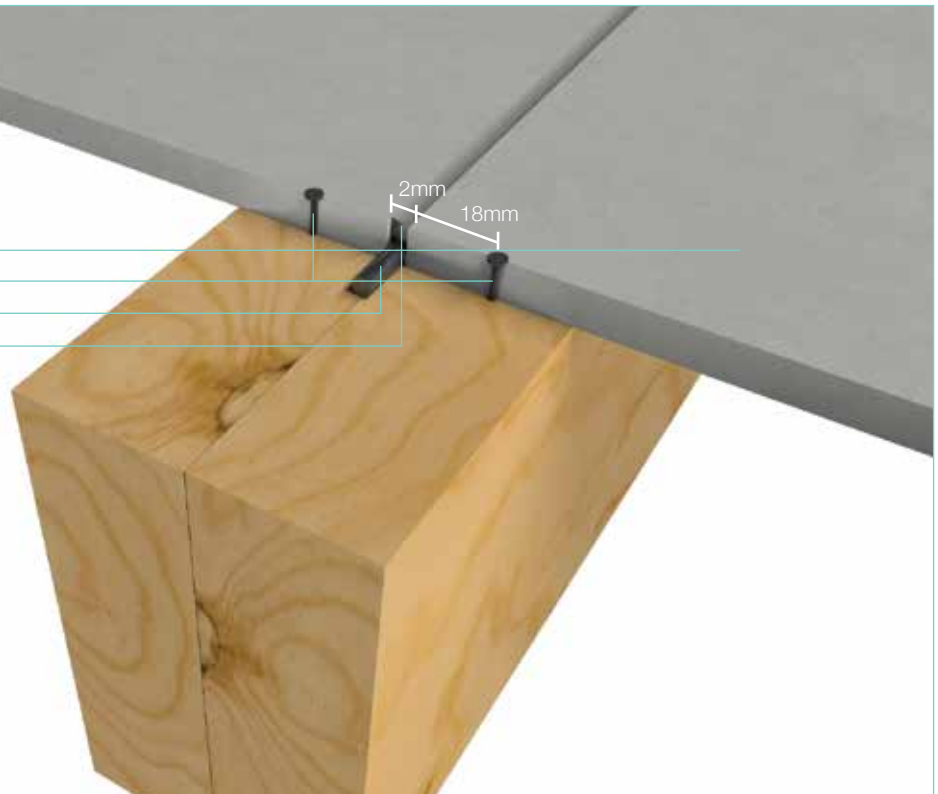

Control Joint

Figure 11
Control Joint Tiled
Non-Wet Areas

Durafloor™
Fasteners*
Polyurethane Sealant*
Primer
Tile Adhesive*
Tiles

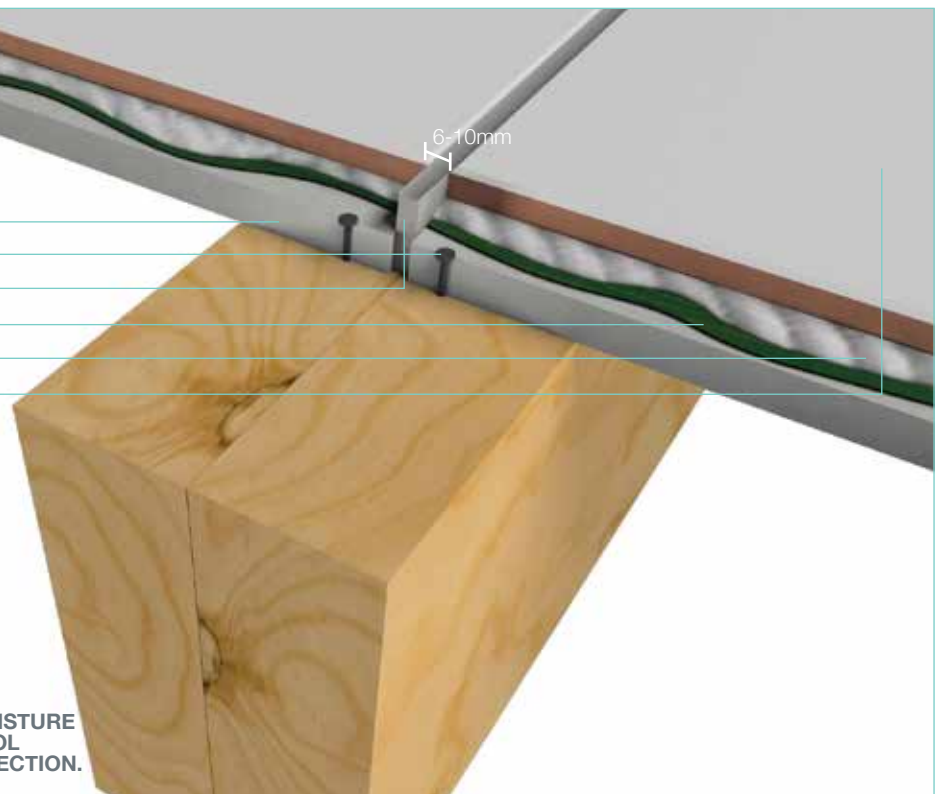

Sheet control joints are required at 3.6m intervals and at a change of direction. This control joint has to be carried through the tiled surface and where existing structural joints are located.

NOTE: TILED AREAS SUBJECT TO MOISTURE AND/OR SUNLIGHT REQUIRE CONTROL JOINTS AT 2.4M TO 3.6M IN EACH DIRECTION.

Installation Details - Interior Tiled Floors

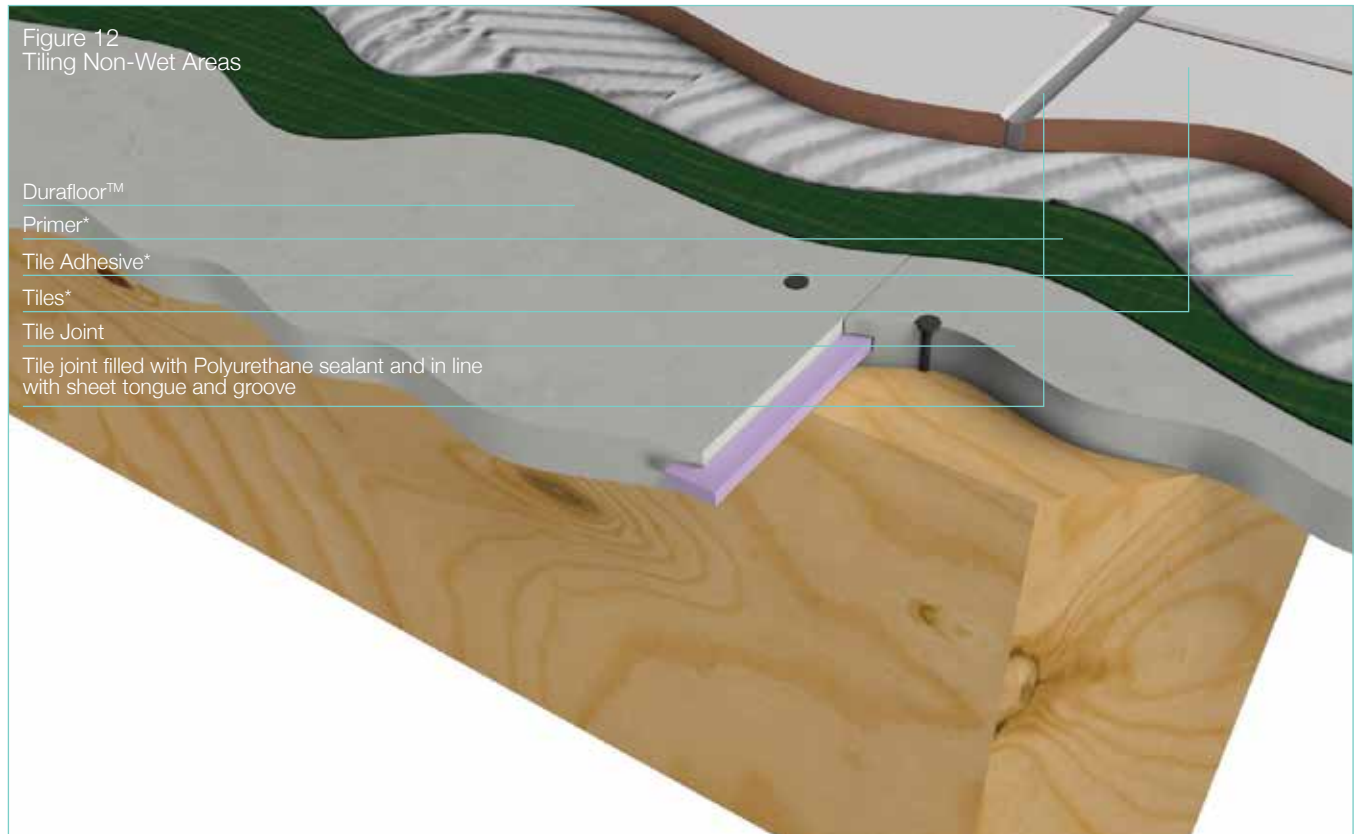

Direct Stick Tiles to Durafloor™

Tiles may be adhered directly to Durafloor™ up to maximum run of 3.6m.

It is recommended the Durafloor™ be primed/sealed prior to installation of membranes and adhesives. Tiling to be installed in accordance with AS3958.1-2007.

Exterior Decking

Durafloor™ can be used as the substrate for a variety of exterior decking applications such as above-ground pool surrounds, verandahs and sundecks.

The basic requirements of two systems are covered in this brochure.

Water Resistant without mortar bed

- / Square sheet layout – refer Fig 14 (max deck width 3600mm)
- / Suitable for tiling (control joints required 2400 – 3600mm in either direction)
- / Applied liquid membrane

Waterproof with mortar bed

- / Staggered sheet layout – refer Fig 13
- / Suitable for large decks
- / Suitable for tiling
- / Minimum requirement over a habitable room or living space
- / Achieved via sheet and/or applied membranes plus slipper sheet and floating reinforced mortar bed

General Requirements

All decks shall have a fall minimum 1:100 to an outside edge. The use of sumps in decking is not recommended.

A step-down of at least 50mm from finished floor height should be provided at any doorways onto the deck.

If a mortar bed is to be used a minimum depth of 40mm is required.

Sheets are laid with the long edges across the joists. Max joist spacing 450mm centres. In all cases a floor joist must support the sheet ends. The exception being the outer edge of decks where a drip angle is installed.

The gap required for control joints needs to be taken into account when setting out the framing.

Ensure compliance with BCA and all relevant standards.

Loading

Durafloor™ satisfies the loading requirements of AS/NZS1170.1 Table 3.1 Category A Domestic and Residential Activities Concentrated Loads 1.8kn @ UDL of 4KPA

For higher load applications, BGC Compressed Flooring is recommended. Please contact your local BGC Fibre Cement office for further details.

Framing

Timber or hot dipped galvanised steel joists are suitable framing members for Durafloor™.

For all applications the joist face width must be no less than 45mm min.

Control joints will require a double joist to facilitate joint width.

It is **STRONGLY** recommended that joist creep control joint position and double joist positions be considered with sheet layout when setting out.

Timber framing must comply to AS1684 of the BCA and the frame maker's recommendations. All timber must be seasoned and stable. **UNSEASONED OR WET TIMBER MUST NOT BE USED.**

Steel joists must comply with AS3623.

Both steel and timber joists must be suitable for the application and exceed the minimum durability and corrosion requirements.

Responsibility rests with the specifier and controlling party of the project. Suitability of structure and all associated details (as recommended here) for the project are controlled by them. Details contained within this document do not cover all possibilities. It is up to the specifier to develop additional details as required.

Waterproofing

Waterproofing a deck is dependant on the membrane and application of that membrane.

Ensure an approved membrane is applied by an approved applicator able to warrant and guarantee the membrane and its application.

Manufacturers like Construction Technologies Australia, RLA Polymers Pty Ltd or Ardex Australia are established manufacturers of these systems.

Ensure compliance with AS/NZ 4654.2.

Sheet Layout - Exterior Decking

TYPE	SHEET LAYOUT	MEMBRANE
Non-Waterproof	Squared	Required when tile finish used AS/NZ 4654.2 2009
Water Resistant	Squared	Applied liquid membrane to AS/NZ Standard 4654.2 2009
Waterproof	Staggered	Sheet Membrane or Applied Membrane to AS/NZ 4654.2 2009 Slip Sheet floating mortar bed to AS/NZ 4654.2 2009

Figure 13
Staggered Sheet Layout

Do not direct stick tiles to this layout
To be used with floating mortar bed only

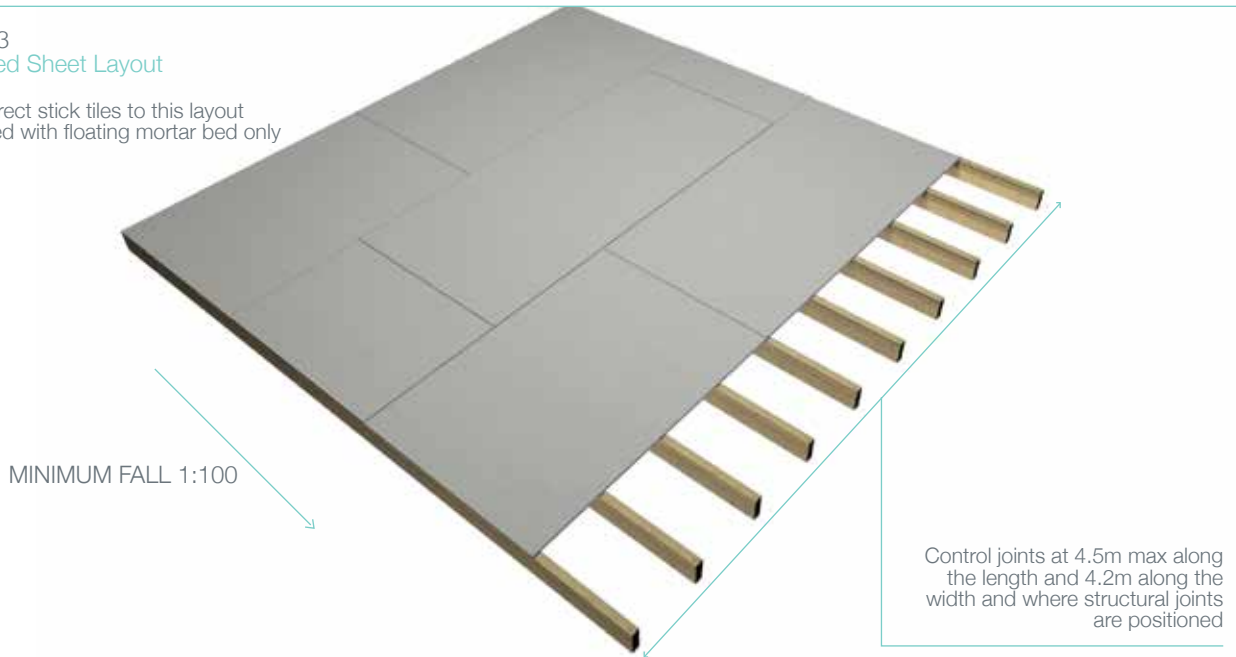
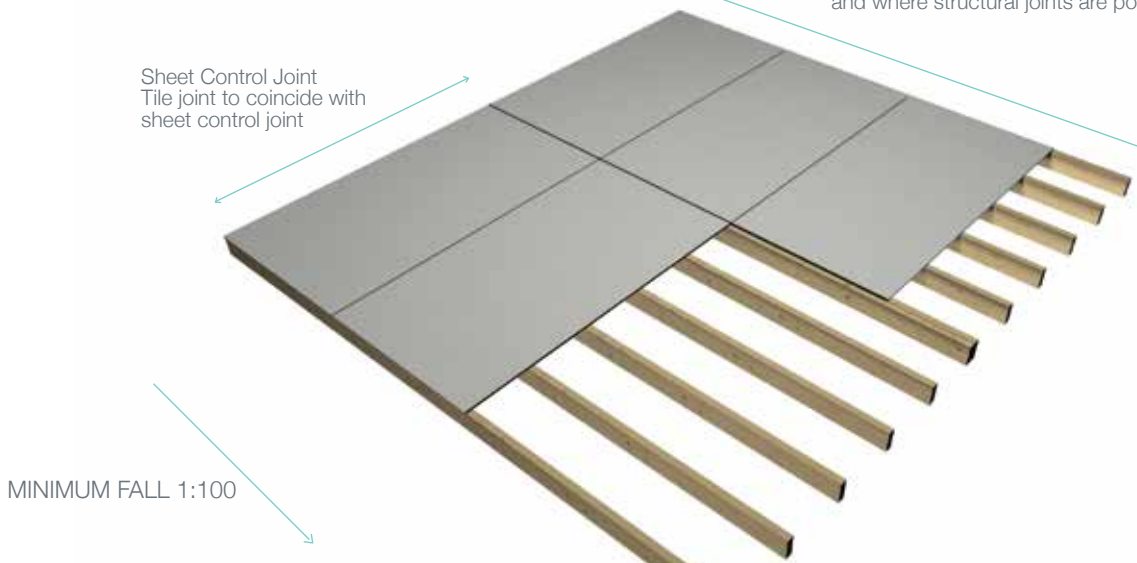

Figure 14
Squared Sheet Layout

Tile control joint is at 3.6m max
To be positioned over tongue and groove joint
and where structural joints are positioned

Sheet Control Joint
Tile joint to coincide with
sheet control joint



Fixing - Exterior Decking

Figure 15
Joist Spacing

Lay the sheets with long edges across the joists, with the ends of sheet supported on the centre line of the joist, as shown in Figure 9.

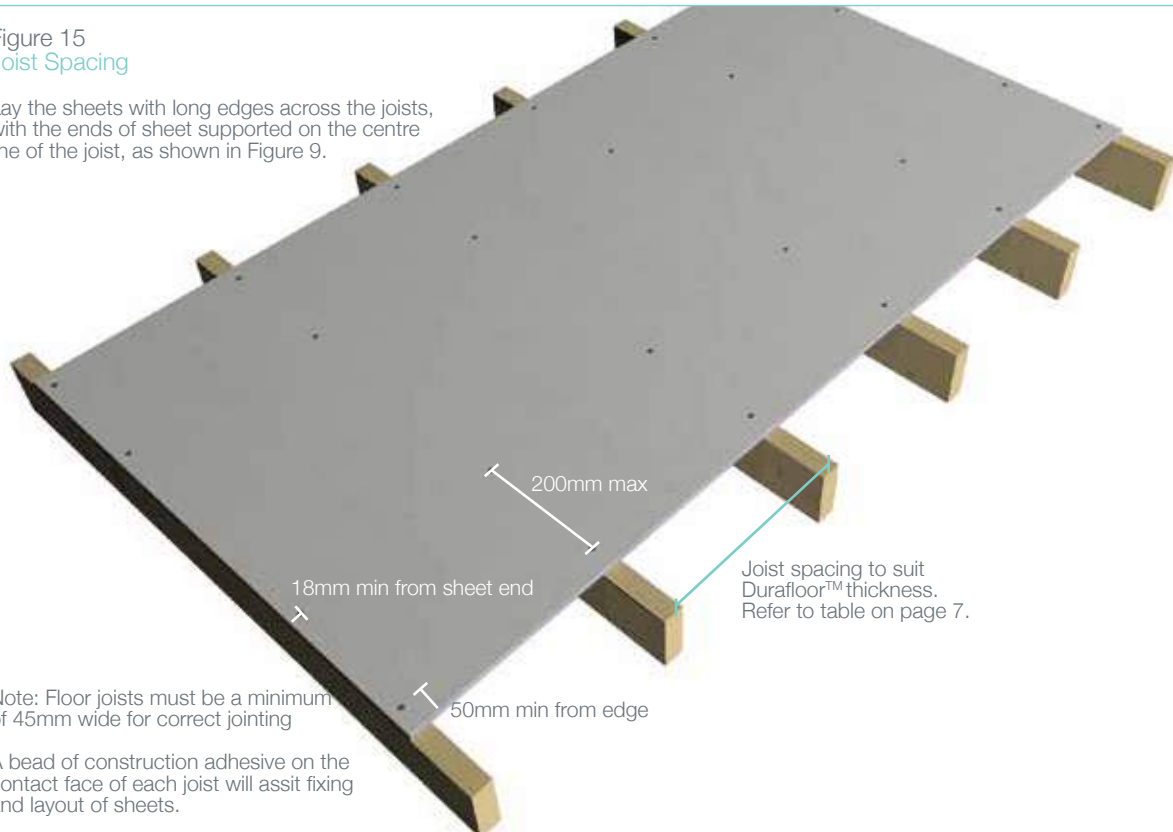

Note: Floor joists must be a minimum of 45mm wide for correct jointing

A bead of construction adhesive on the contact face of each joist will assist fixing and layout of sheets.

Figure 16
Control Joints

Vapour Permeable Sarking*
Durafloor™
Backing Rod*
Polyurethane Sealant*

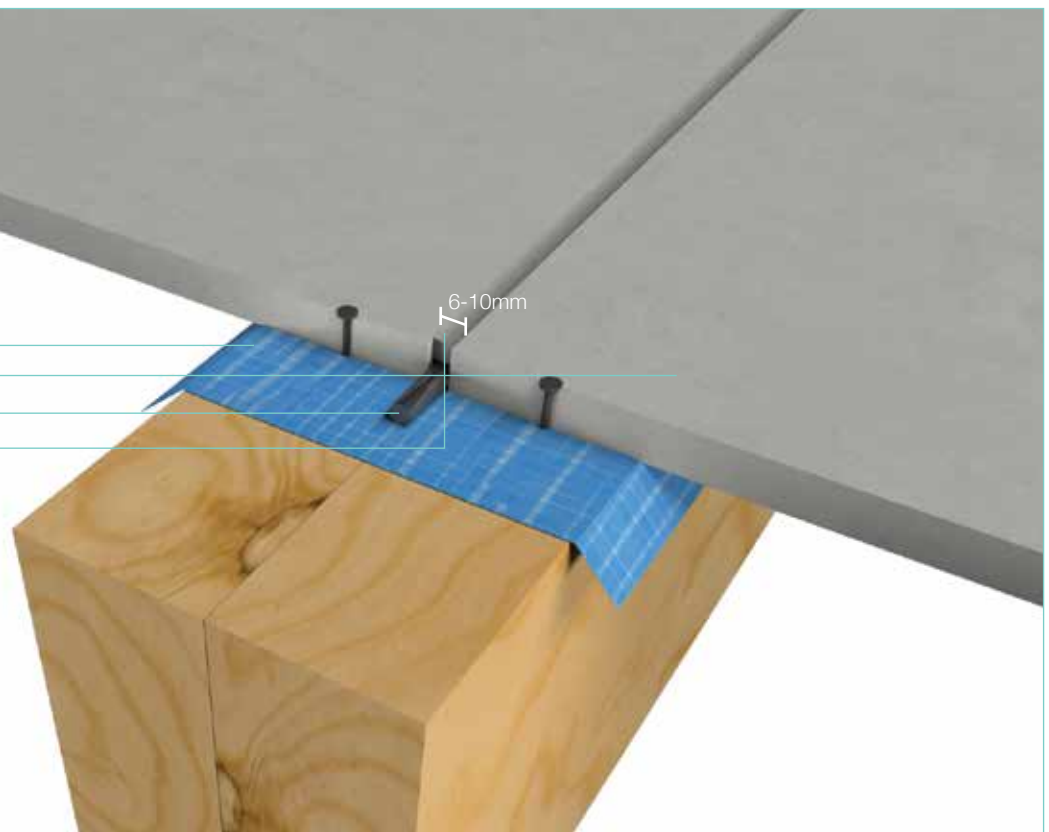

Fixing - Exterior Decking

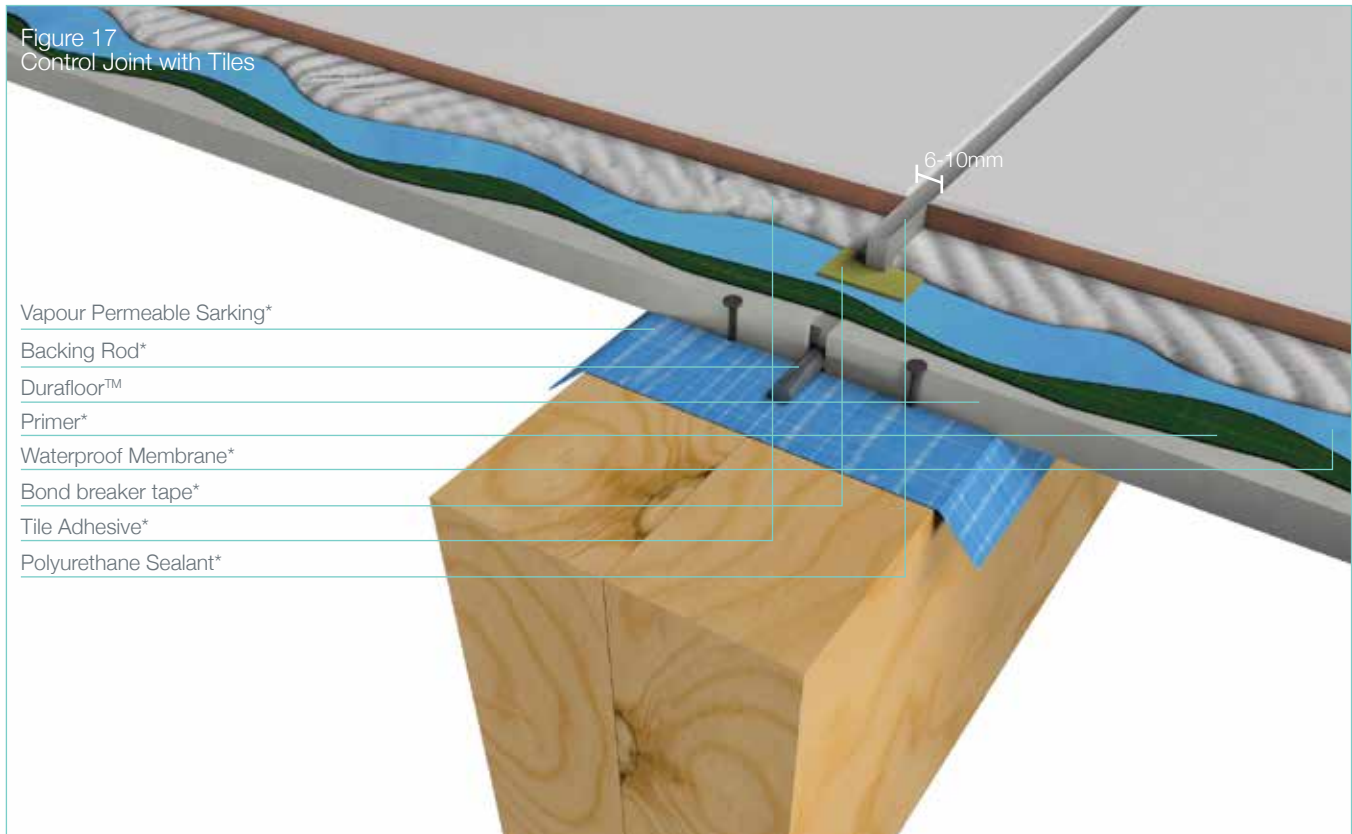

Sealing

After fixing, the screw holes should be sealed using a polyurethane sealant to prevent ingress of water into the framing.

Fasteners

Durafloor™ can be fixed to either timber or lightweight steel framing. All fasteners to be a minimum Class 3 Corrosion Resistant

Timber: Powers Muro Decking Screw M1062:10g x 50
Paslode HDG Coil Nail 45 x 2.5

Steel: Buildex: SEH Wingtek 10g x 16 x 40 or 10g x 16x 45
Powers Muro Self Drilling Wing M1024

Or equivalent

Deck Finishing Details

Figure 18
Deck Finishing with Tile Face



Figure 19
Deck Finishing

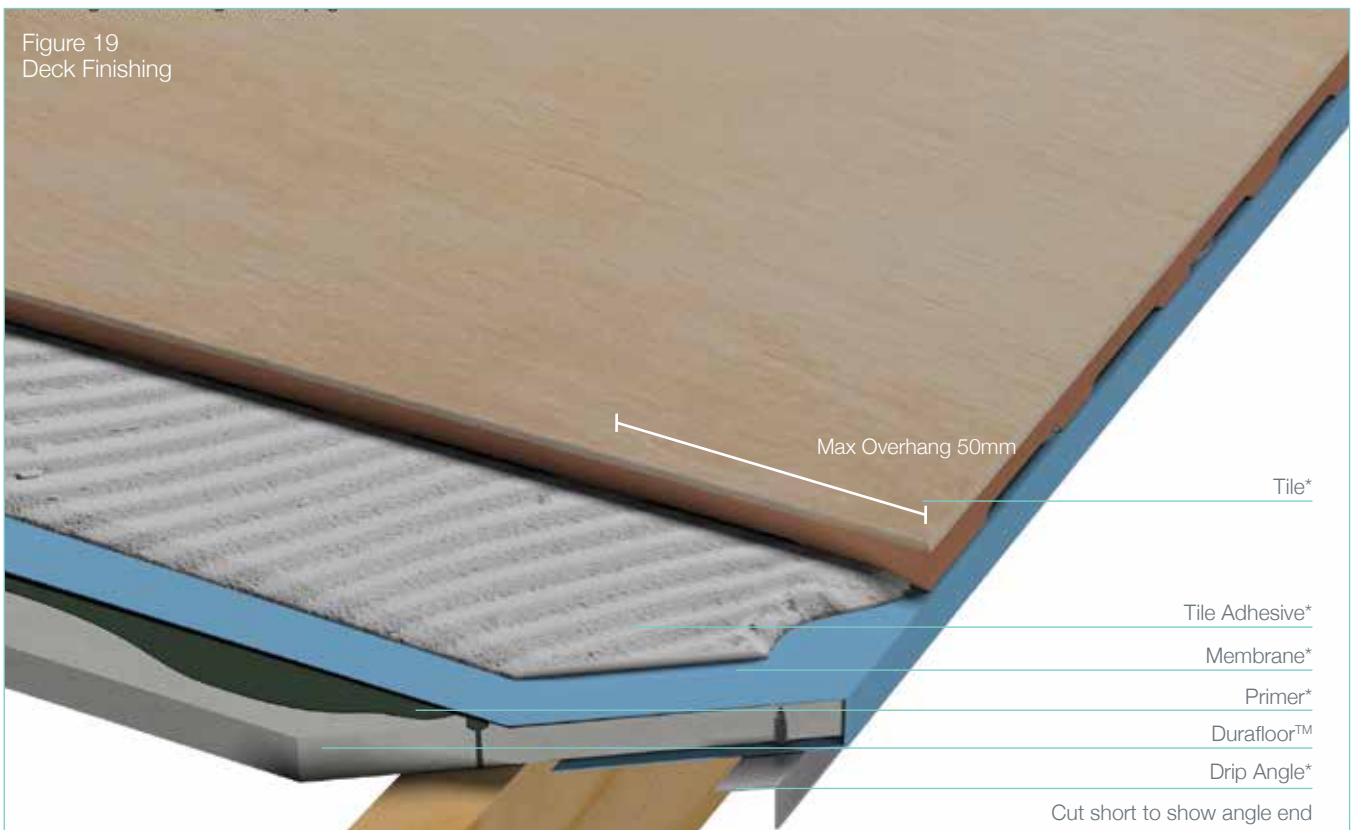

Exterior Deck – Water Resistant without Mortar Bed

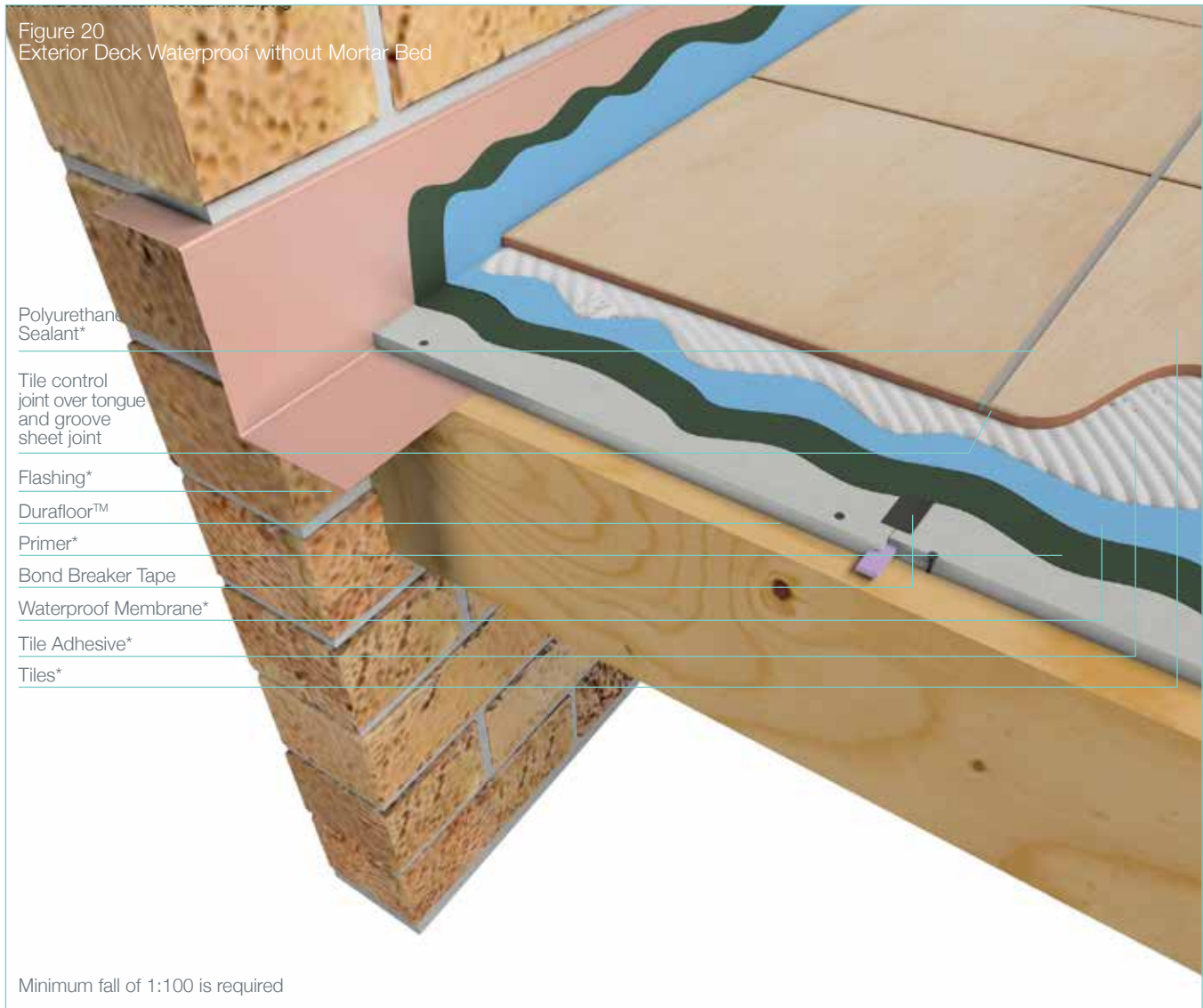

Sheet Preparation
Waterproofing

Waterproofing a deck is dependant on the membrane and application of that membrane.

Ensure an approved membrane is applied by an approved applicator able to warrant and guarantee the membrane and its application.

Manufacturers like Construction Technologies Australia, RLA Polymers Pty Ltd or Ardex Australia are established manufacturers of these systems.

Ensure compliance with AS/NZ 4654.2.

Typical examples are:

- / Primer – RLA Polymers – CTA Prep ‘n’ Prime or Uniflex Additive (Typical) or Ardex Multiprime
- / Membrane – RLA Polymers Dryflex Pump (Typical) Ardex WPM 001/002/Aquablok SBR / Aquablok 2-part
- / Tile Adhesive – RLA Polymers Flexi Part or Ardex x77, CTA MCB A80 or CTA Pro Premium
- / Tiles – As per manufacturer’s recommendations.

*Components not supplied by BGC

Exterior Deck – Waterproof with Mortar Bed

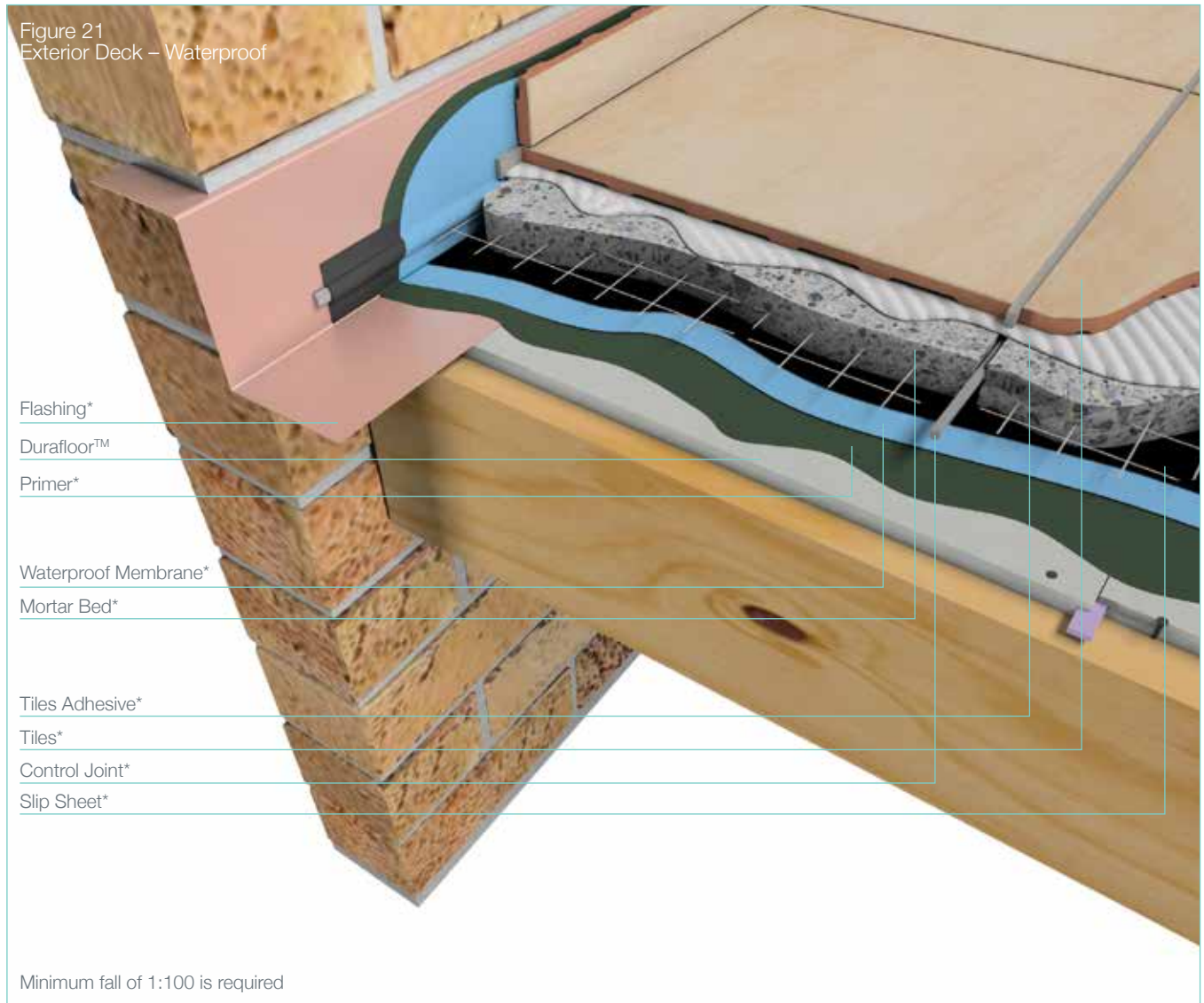

Sheet Preparation – For Tiling Waterproofing

Waterproofing a deck is dependant on the membrane and application of that membrane.

Ensure an approved membrane is applied by an approved applicator able to warrant and guarantee the membrane and its application.

Manufacturers like Construction Technologies Australia, RLA Polymers Pty Ltd or Ardex Australia are established manufacturers of these systems.

Ensure compliance with AS/NZ 4654.2.

- / 1 layers of slip sheet i.e. 200 micron plastic builders sheet
- / Reinforced mortar bed minimum 40mm thick as per Australian Standard AS4654 2 (2009). Sand cement screed with Ardex Abacrete (or similar) reinforced with 75 x 75 2.5mm galvanised weld mesh or equivalent

Control joints at 4.5m centres in mortar bed.
Express control joints through tiles.

Sheet control joints at 4.5m max. intervals in a staggered pattern

*Components not supplied by BGC

Sheet Preparation

Tiles – Consult

/ AS3958.1 Part 2 – Guide to Installation of Ceramic Tiles
/ AS2358 – Adhesives for Fixing Ceramic Tiles

Other Finishes – Consult manufacturer for their recommendation and ensure installation complies with the recommendation provided.

Membranes

Applied Membranes (Exterior Decks)

In all instances consult with manufacturer for exact method and specification.

Sheet Membranes

In all instances consult with manufacturer for exact method and specification.

Maintenance

Maintain the finished surface, keeping the surface clean and free of build up or residue.

Repair and maintain joints, junctions, tiles and grout that are damaged or deteriorated.

Ensure membranes are not prejudiced in any way as damage to these may result in diminished performance and leakage.

Warranty

We warrant that our products are free from defects caused by faulty manufacture or materials for a period of 15 years from the date of purchase. If you acquire any defective products, we will repair or replace them, supply equivalent replacement products or refund the purchase price within 30 days of receiving a valid claim subject to product inspection and confirmation of the existence of a defect by BGC. We will bear the cost of any such repair, replacement or refund.

This warranty is given by:

BGC Fibre Cement Pty Ltd
121 Bannister Rd Canning Vale WA 6155
Phone 08 9334 4900 Fax 08 9334 4749

To claim under this warranty, you must provide proof of purchase as a consumer and make a written claim (including any costs of claiming) to us at the address specified above within 30 days after the defect was reasonably apparent, or if the defect was reasonably apparent prior to installation, the claim must be made prior to installation. You may not claim under this warranty for loss or damage caused by:

- faulty or incorrect installation by non-BGC installers (BGC's installation procedures are at www.bgcinnovadesign.com.au);
- failure to comply with the Building Code of Australia or any applicable legislation, regulations approvals and standards;
- products not made or supplied by BGC;
- abnormal use of the product; or
- normal wear and tear.

The benefits available under this warranty are in addition to other rights and remedies of the consumer under the law. Our goods come with guarantees that cannot be excluded under the Australian Consumer Law. You are entitled to a replacement or refund for a major failure and for compensation for any other reasonably foreseeable loss or damage.

You are also entitled to have the goods repaired or replaced if the goods fail to be of acceptable quality and the failure does not amount to a major failure.

Terms and Conditions

BGC Fibre Cement's Terms and Conditions of Sale ("Agreement"), as in place and published at the date of this brochure, which are available upon request or on our website at www.bgcinnovadesign.com.au. The purchaser's terms and conditions, howsoever provided, do not form part of the Agreement.

Adelaide
Telephone
08 8250 4962

Sydney
Telephone
02 9771 9660

Brisbane
Telephone
07 3271 1711

New Zealand
Telephone
0011 64 9273 1457

Melbourne
Telephone
03 9392 9444

Technical help line
1300 652 242

Perth
Telephone
08 9334 4900

Exterior products and applications
INNOVA™ RANGE OF PRODUCTS

- DURACOM™** / A compressed fibre cement facade system.
- DURAFLOOR™** / Is the ultimate flooring product that can be used in both interior and exterior applications.
- DURAGRID™ RESIDENTIAL & DURAGRID™ LIGHT COMMERCIAL /**
A lightweight facade giving a modern and durable finish.
- DURAGROOVE™** / A vertically grooved exterior facade panel.
- DURASCAPE™** / A lightweight exterior facade base sheet with a subtle vertical shadow line.
- NULINE™ PLUS** / A weatherboard style cladding system.
- STONESHEET™** / Purpose designed substrate for stone tile facade.
- STRATUM™** / Is a range of plank products, each of which can be used as stand-alone products or used together to create a striking exterior cladding solution.
- STRATUM™ ERA** / A traditional, yet contemporary weatherboard.

Exterior products and applications
BGC FIBRE CEMENT RANGE OF PRODUCTS

- DURASHEET™** / Ideal for the cladding of gables and lining of eaves. Can also be used on commercial soffits and cladding on non-impact areas.
- DURAPLANK™** / Available in Smooth, Woodgrain and Rusticated finishes, Duraplank™ is ideal for exterior cladding of upper storey conversions or ground level extensions.
- DURATEX™** / A base sheet used for textured coatings on exterior wall applications.
- DURALINER™ PLUS** / An exterior lining board that is the perfect substrate for tiles and is ideal for wet areas.
- DURALATTICE™** / Square or diamond patterned lattice, suitable for screens, pergolas and fences.
- COMPRESSED** / Used for domestic, commercial sheet for wet areas, flooring, partitions, exterior decking, fascia and facade cladding.
- DURALUX™ PLUS** / Suitable for exterior applications where it will be sheltered from direct weather.

Interior products and applications
BGC FIBRE CEMENT RANGE OF PRODUCTS

- DURALUX™ PLUS** / An interior lining board suitable for ceilings and soffits.
- DURALINER™ PLUS** / An interior lining board, this is the perfect substrate for tiles and is ideal for wet areas.
- CERAMIC TILE UNDERLAY** / A substrate for ceramic and slate floor tiles.
- VINYL CORK FLOOR COVERINGS** / A substrate for vinyl floors.